

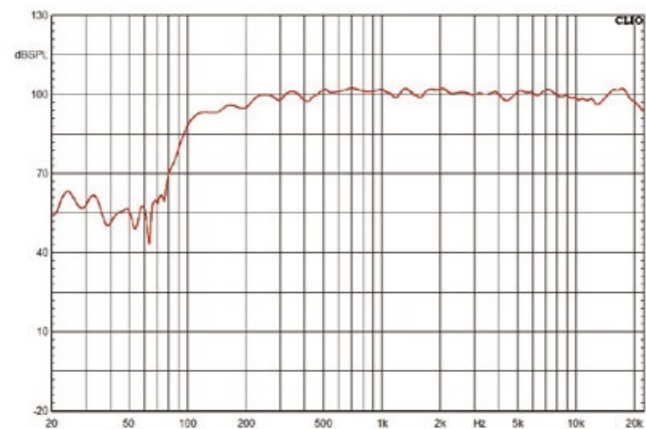

VS808/212 MAX SERIES

The VS808/212 MAX Series is a modular active line array system designed for professional sound reinforcement. Each speaker comes with an integrated amplifier module, providing flexibility in system configuration and tuning. This allows for scalable setups, making it suitable for both temporary and permanent installations in a variety of venues.

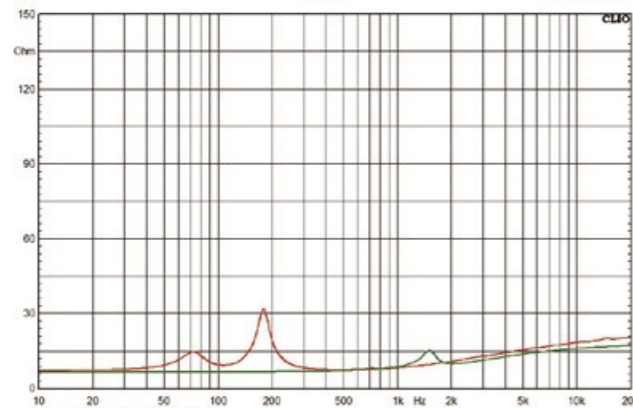

Compact, High-Performance Line Array

The VS808 MAX is a high-output, compact line array featuring 8 x 3-inch neodymium midrange drivers and 8 x 1-inch neodymium high-frequency drivers. Its hornless design ensures 120° horizontal and 16° vertical coverage, delivering clear and natural sound with minimal distortion. Powered by an 800W Class D amplifier, it achieves peak SPL of 130dB. Built-in DSP provides 6 preset programs for optimized audio quality.



VS808 MAX

Powerful Low-Frequency Extension

The VS212SUB MAX is a high-power subwoofer designed to extend low-frequency response down to 40Hz. Featuring dual 12-inch neodymium drivers and an 1800W Class D amplifier, it delivers deep, impactful bass with stable performance. The advanced DSP control ensures precise low frequencies, making it ideal for environments that require powerful bass reproduction.



VS212SUB MAX

Flexible Setup Options

The VS808 MAX Series offers three setup configurations: stacking, with support poles, or hanging, providing flexibility for any venue. The modular design supports scalable and customizable sound reinforcement for varying acoustic needs. The GLL file for this line array is available for download on our website: cafsound.com.



Applications



LIVE EVENTS:

Ideal for medium to large-scale concerts, festivals, and performances.



THEATERS AND AUDITORIUMS:

Consistent, high-quality sound across large seating areas.



THEME PARKS, MUSEUMS AND HOTELS:

Perfect for immersive sound experiences and outdoor installations.



CORPORATE FUNCTIONS AND CONFERENCES:

Reliable audio for presentations, trade shows, and corporate events.

Application



The VS808/212 MAX series features independent, modular designs for flexible configurations. The setup shown above includes two subwoofers and eight line array units on each side of the stage.

	VS808 MAX	VS212SUB MAX
Drivers	MF 8x3" neodymium HF 8x1" neodymium	2x12" neodymium
Frequency Response (-3dB)	120Hz~18.5kHz	40Hz~300Hz
Dispersion (-6dB)	Hor.120°x Vert.16°	/
Max SPL	124dB (continuous)/130dB (peak)	124dB (continuous)/130dB (peak)
Power (RMS standards)	800W	1800W
Amplifier Circuitry	Class D	Class D
DSP Sampling Rate	96kHz/24-bit	96kHz/24-bit
DSP Input Channels	1 in 2 out	1 in 1 out
AC Power Operating Range	AC100~240V, 50/60Hz	AC100~240V, 50/60Hz
THD	≤0.05%	≤0.05%
Input/Output Connectors	XLR-F/M	XLR-F/M
Dimensions (HxWxD)	360 x 260 x 288 mm	706 x 400 x 580 mm
Net weight	13 kg	44 kg

Dimensions

VS808 MAX

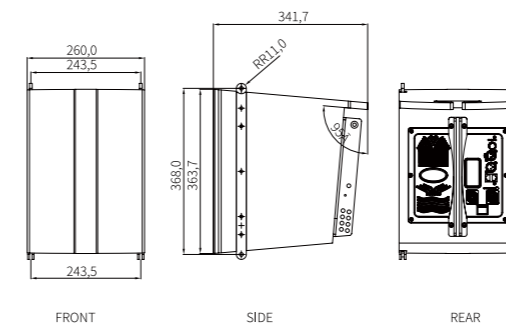

VS212SUB MAX

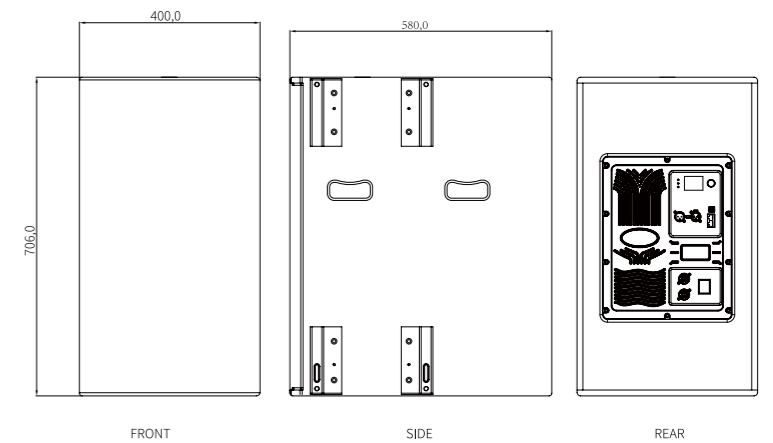

Accessories

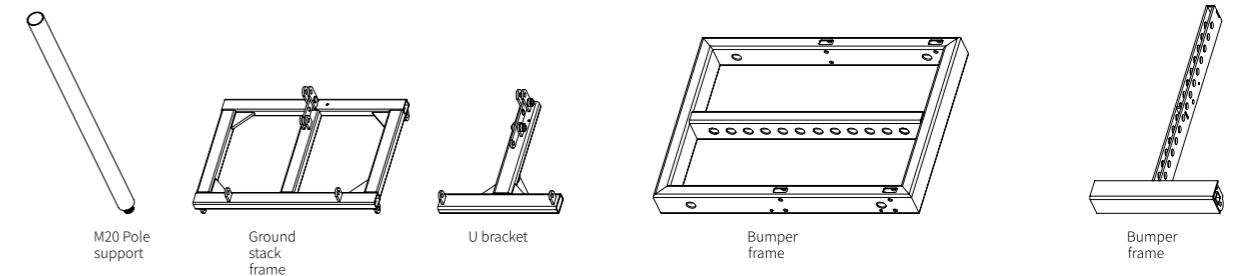

Configurations

1. Line array

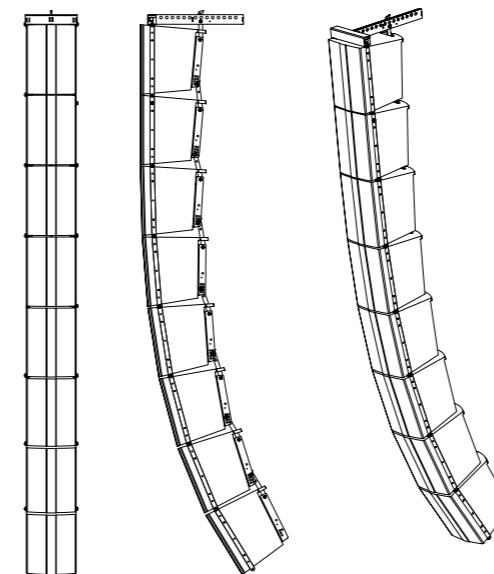

2. Ground stacking

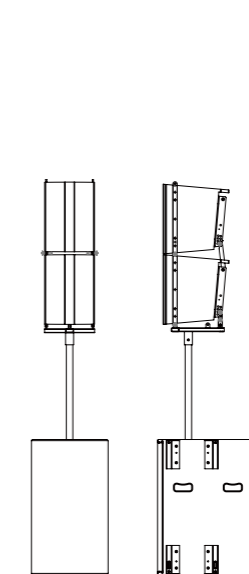

3. Ground stacking

